

**TOORX**  
FITNESS IN MOTION

# INSTRUCTION

CHRONO PRO  LINE



# TRX 2500 TFT



Cod : TOXPRFTRX2500T

Rev : 00

Ed : 04/23



# Exploded drawing

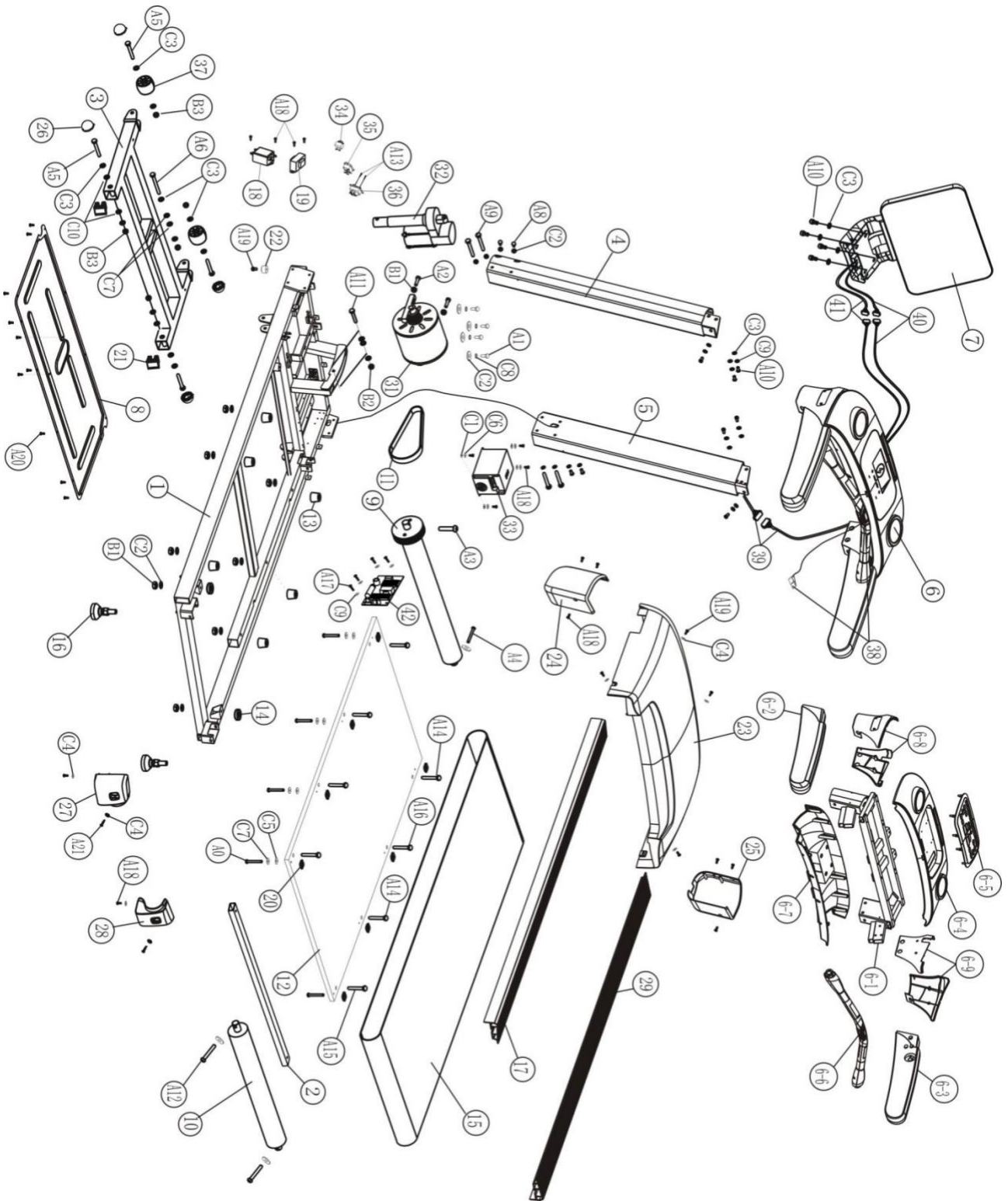

## Parts list

No.	Description	Qty	No.	Description	Qty	No.	Description	Qty
1	Base frame	1	28	Right rear end cap	1	A13	Cross head sunk screw M3X8	2
2	Running board supporting tube	1	29	Right side rail	1	A14	Cross head sunk screw M8X25	4
3	Incline frame	1	31	Motor	2	A15	Cross head sunk screw M8X30	2
4	Left upright tube	1	32	Incline motor	1	A16	Cross head sunk screw M8X35	3
5	Right upright tube	1	33	Controller	1	A17	Cross pan head screw M3*16	4
6	Handlebar and controlling panel	1	34	Safety switch	1	A18	Cross pan head tapping screw ST4.2X12	16
6.1	Controlling panel support	1	35	Power switch	1	A19	Cross pan head tapping screw ST4.2X16	6
6.2	Left handlebar	1	36	Socket	1	A20	Cross pan half round screw ST4.2X12	15
6.3	Right handlebar	1	37	Wheel	2	A21	Cross pan half round screw ST4.2X25	2
6.4	Upper cover of controlling panel	1	38	Emergency stop switch	38			
6.5	Key board	1	39	Signal wire A	39			
6.6	Front handlebar	1	40	Signal wire B	40			
6.7	Lower cover of controlling panel	1	41	Signal wire C	41			
6.8	Left handlebar cover	1-1	42		42			
6.9	Right handlebar cover	1-1	43		43	B1	Hex nut M8	2
7	Display screen	1			44	B2	Nylon lock nut M8	8
8	Motor lower cover	1			45	B3	Nylon lock nut M10	6
9	Front roller	1						
10	Rear roller	1						
11	8V belt	1				C0	Flat washer $\Phi$ 4	4
12	Running board	1				C1	Flat washer $\Phi$ 6	14
13	Running board cushion	6				C2	Flat washer $\Phi$ 8	11

14	Rubber mat	2				C3	Flast washer Φ10	20
15	Running belt	1	A0	Bolt M5X35	8	C4	Big flat washer Φ4	10
16	Universal foot pad	2	A1	Bolt M8X30	4	C5	Big flat washer Φ5	8
17	Left side rail	1	A2	Bolt M8X50	2	C6	Spring washer Φ4	8
18	Filter	1	A3	Bolt M8X25	1	C7	Spring washer Φ5	8
19	Inductor	1	A4	Bolt M8X60	1	C8	Spring washer Φ8	4
20	Side rail positioning nut	6	A5	Bolt M10X75	4	C9	Spring washer Φ10	8
21	Square end cap	2	A6	Bolt M10X90	1	C10	Nylong washer Φ10	4
22	Cushion	2						
23	Motor upper cover	1	A8	Half round bolt M8X20	4	D1	Screwdriver	1
24	Left upright tube cover	1	A9	Half round bolt M8X65	4	D2	Wrench (S=6)	1
25	Right upright tube cover	1	A10	Half round bolt M10X25	10	D3	Wrench (S=8)	1
26	Nut cap	4	A11	Bolt M10X50	1	D4	Lubricant bottle	1
27	Left rear end cap	1	A12	Socket head bolt M8X90	2			

Note: Pls refer to the actual parts if there is difference with the ones in the list.

## Installation instruction



**WARNING:** Don't insert the power wire until the treadmill was fully installed!

### Tips:

\* To eliminate installation errors, do not tighten all the bolts in each step. Tighten all the bolts after the installation is complete.

\* One treadmill is packed in 2 cartons, #1 is for main frame, # 2 is for the handle bar and central controlling panel.

### 1. Unpack and lift out of the frame

The frame is fixed with a bracket and bolt X, unscrew the X (there are six in total) mounted on the frame with a wrench. Then lift the frame out. As shown in Figure 1

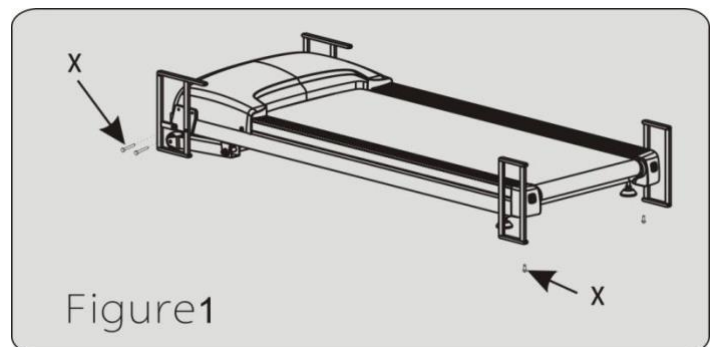

## 2. Installation of left upright tube

Install Left upright tube (4) to base frame (1) by two sets of half round bolt M8X20 (A8), half round bolt M8\*65 (A9) and four pcs of flat washer  $\phi 8$  (C2) by side. (Attention: to align screw hole with the upper surface). Make sure the bolts to connect left upright tube and base frame. Do not tighten the bolts until all the bolts are assembled. (See Figure 2)

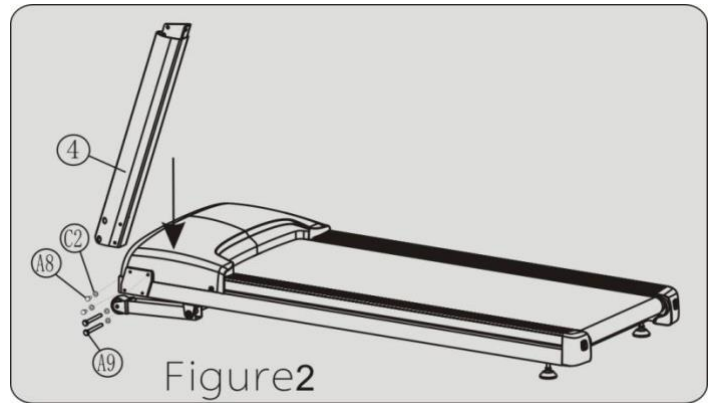

## 3. Installation of right upright tube

3.1 Connect the Signal wire from right upright tube to corresponding socket from frame.

3.2 Install the Right upright tube (5) to base frame (1) using two sets of bolt M8X20 (A8), bolt M8X65 (A9) and four pcs of flat washer  $\phi 8$  (C2) by side. (Attention: to align screw hole with the upper surface). Make sure the bolts to connect right upright tube and base frame. Do not tighten the bolts until all the bolts are assembled. (See Figure 3)

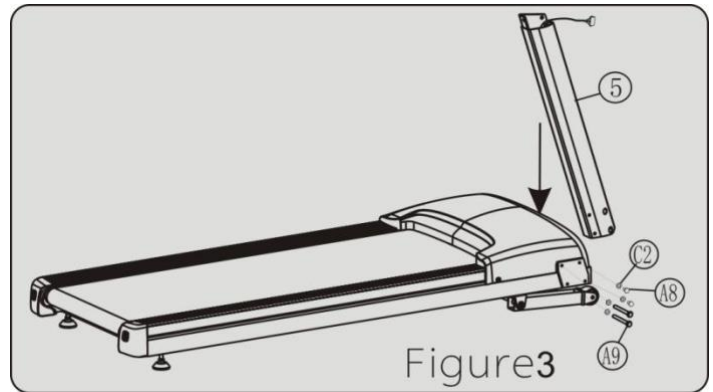

## 4. Installation of handlebar and controlling panel

4.1 Connect the Signal wire from right upright tube to corresponding socket from Handlebar.

4.2 Install handlebar and controlling panel set (6) to the left/right upright tube (4/5).

4.3 Connect handlebar and controlling panel (6) to the left/right upright tube (4/5) from inner and front sides by six sets of half round bolt M10X25 (A10), spring washer  $\phi 10$  (C9), and flat washer  $\phi 10$  (C3). (Attention: To align screw hole) (See Figure 4)

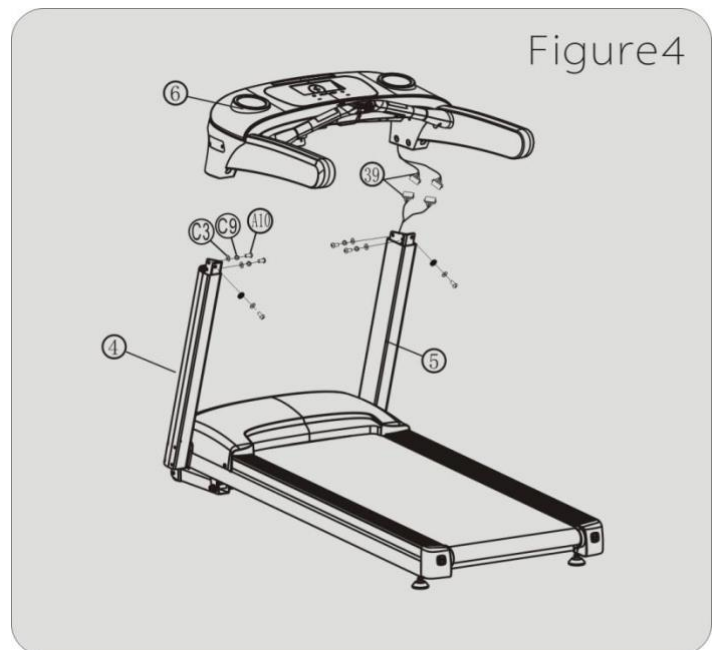

## 5. Installation of display screen

5.1 Connect the socket from display screen to corresponding wire from controlling panel. Crowding the extra wire into the panel.

5.2 Connect the display screen (7) to handlebar and controlling panel (6) by four sets of half-round bolt M10X25(A10), flat washers  $\phi$ 10(C3). (Attention: To align screw hole) (See Figure 5)

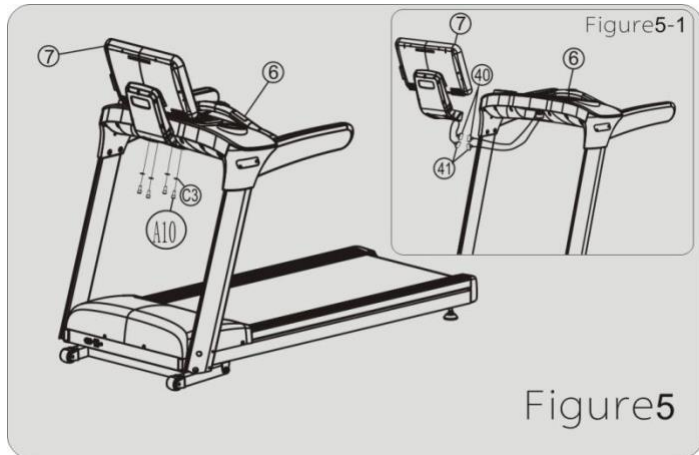

Figure5

## 6. Installation of left/ right upright tube cover

6.1 Tighten all the bolts.

6.2 Install left cover (24) to the left side of motor upper cover (23) by three pcs of cross pan head tapping screw ST4.2X12 (A18), then tighten.

6.3 Install right cover (25) to the right side of motor upper cover (23) by three pcs of cross pan head tapping screw ST4.2\*12 (A18), then tighten. ( see Figure 6)

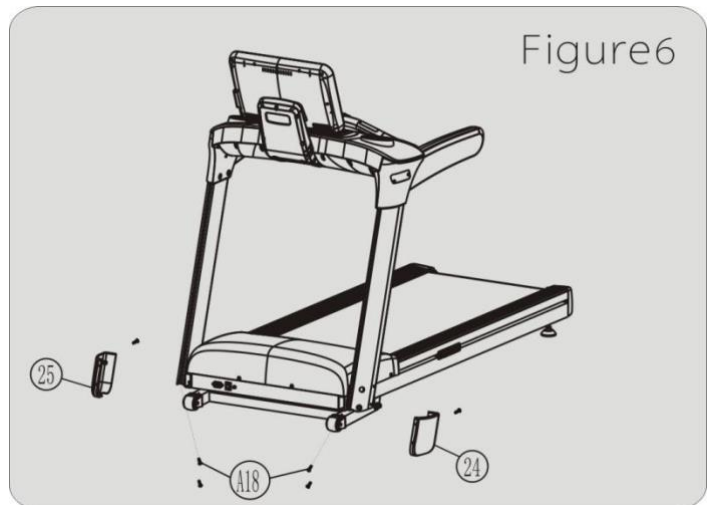

Figure6



**WARNING:** Improper connection of the grounding conductor may cause electric shock. If you are not sure whether the device is properly grounded, please turn to a professional electrician or repairman to inspect. Do not modify the plug supplied with the product, if the plug does not match the socket, you should turn to a professional electrician to install a proper socket.

## Adjustment instruction

1. Before connecting power, service or professional person should check whether voltage is appropriated, and whether the ground wire of three-core plug is wellconnected. Pull the running belt by hand, check whether the rotation is flexible, there is no abnormal sound.

2. Connect power, press Start key, the treadmill starts to run in low speed, observe whether belt and console are run normally.

3. Press the speed up and down key to observe the rotation and display of the treadmill. If the belt deviated, stop the treadmill and adjust the running belt according to the

requirements of "maintenance".

4. Press emergency stop key or pull out safety key, the treadmill will stop immediately. Re-insert the emergency stop key to reset or insert safety key, can restart treadmill. (As below figure)

5. Press Stop key, the treadmill stop running, then turn off the power when the incline returns to zero.

**Treadmill can be put into use after all the installation adjustment is completed.**

1. Two feet stand on two side of belt, put the other side clip from safety key to clip to clothes. (see the figure)

2. Press Start key, the treadmill will start running at lowest speed. You can step on the belt and walk slowly.

3. Press speed+ key, the speed of running belt will gradually increase, you can see the speed value from computer, start to run at low speed for 2-3 minutes, then increase the speed to your target, you can release the handlebar after after run is suitable, you can let go handrail to run after adaptation.

4. When stopping running, you should slow down gradually and run for 2-3 minutes at a low speed, so that the heart and breathing slowly return to normal.

5. After running, you can reduce speed to the minimum, and then press the start/stop button to stop the treadmill.

6. If running at high speed, it is too late to slow down, or even lose balance, you can press the emergency stop button, and the treadmill can stop running immediately. The stopping distance depends on the inertial weight.

7. Please fully master the use of emergency stop button and safety key.

8. If the emergency stop button and safety key fail or are damaged, they must be maintained or replaced by professionals in time. (They are easily worn parts)

9. Noise under load is higher than that without load.

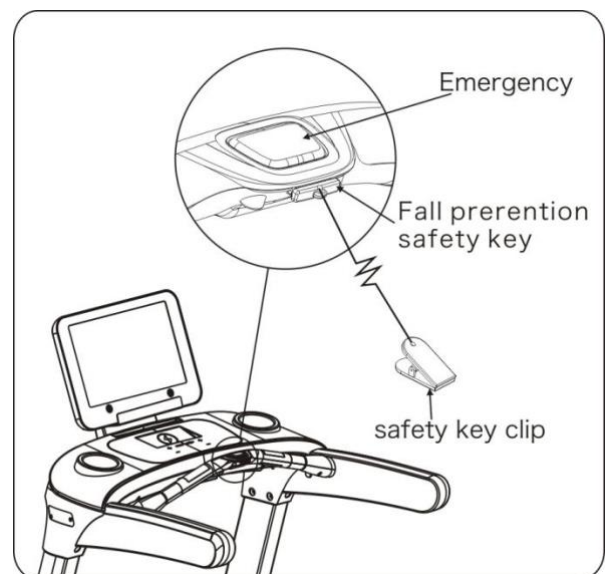



**WARNING:** Frequent use of incline operation (more than 5 times in a row) may render the incline ineffective. It's not a malfunction. It is a kind of automatic protection of incline motor, the function will be restored automatically after 1 hour stop using.

## Console instruction



**WARNING:** To reduce the possibility of electric shock, keep the console dry. To prevent liquid from spilling onto the console, only sealed water bottles can be placed on the water bottle holder.

### 1. Quick start

The treadmill adopts 15.6 inch high resolution touch screen to display the data and sports state during exercise, and installs multimedia APP application and running training mode to make sports entertainment more rich and interesting. Power on, turn on the main power switch of the treadmill, install the safety switch key then enter into the main menu as shown below

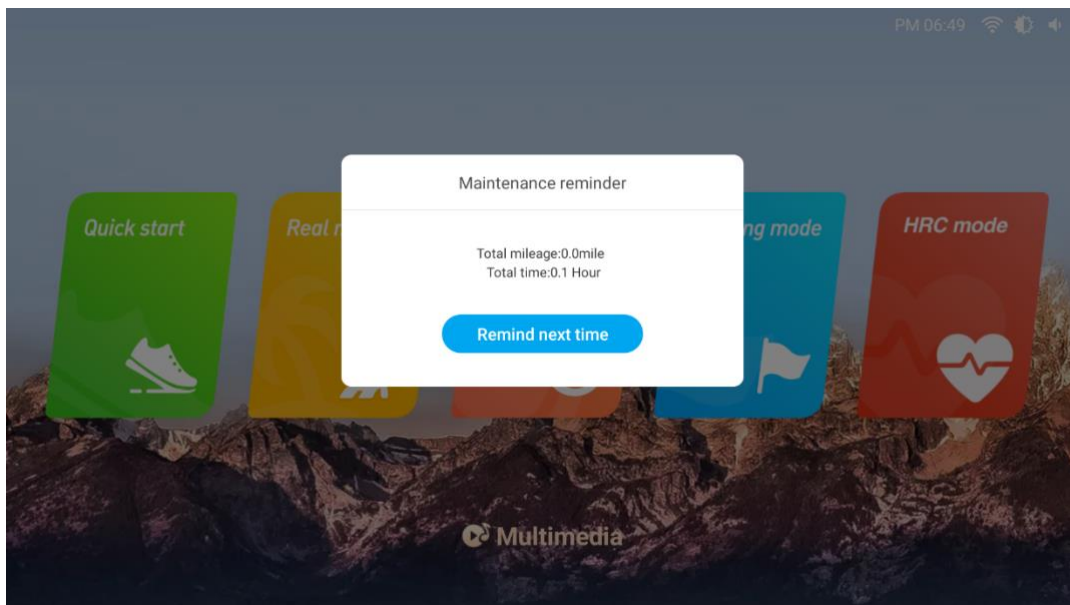

Click **Remind next time** to exit the "Maintenance reminder" and enter into main menu as shown below:



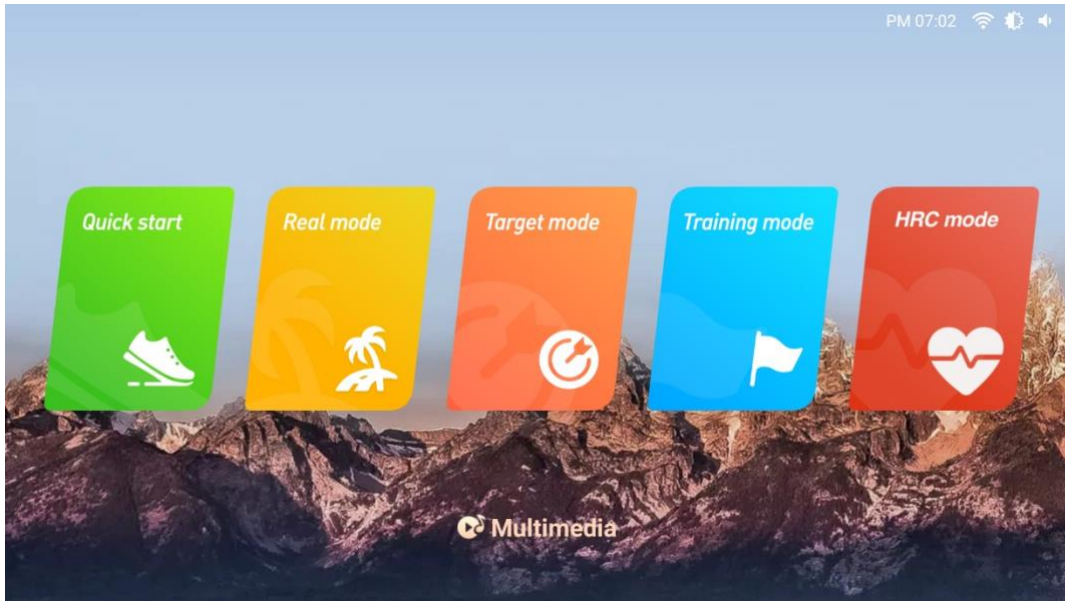





Click "Quick Start" on the screen or the "START" button on the console to start quickly. The treadmill will directly start the countdown and enter running mode as shown below:

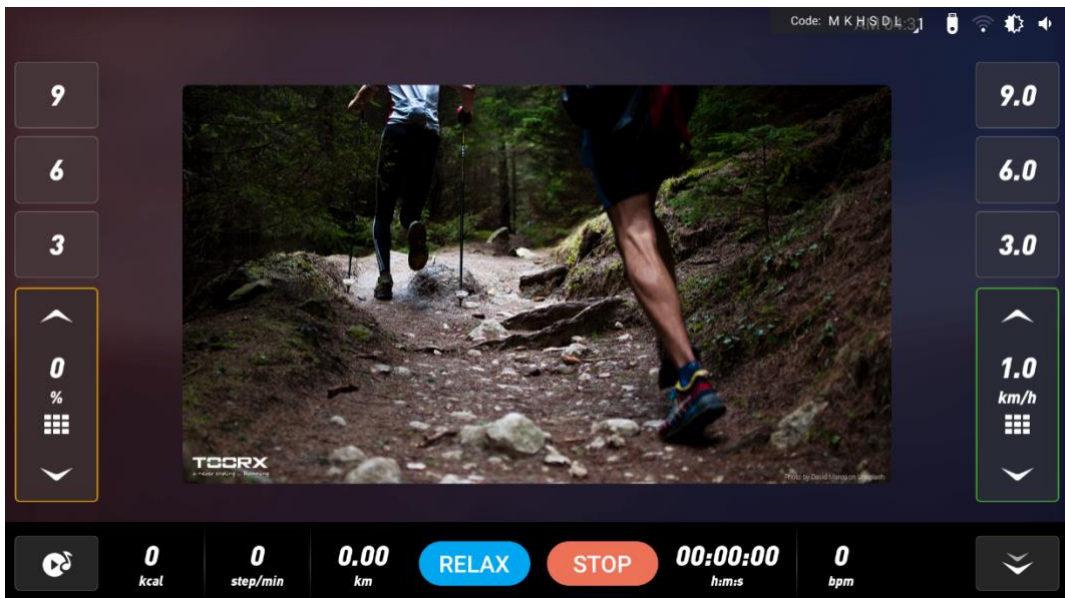



Main interface in running state is shown as below:

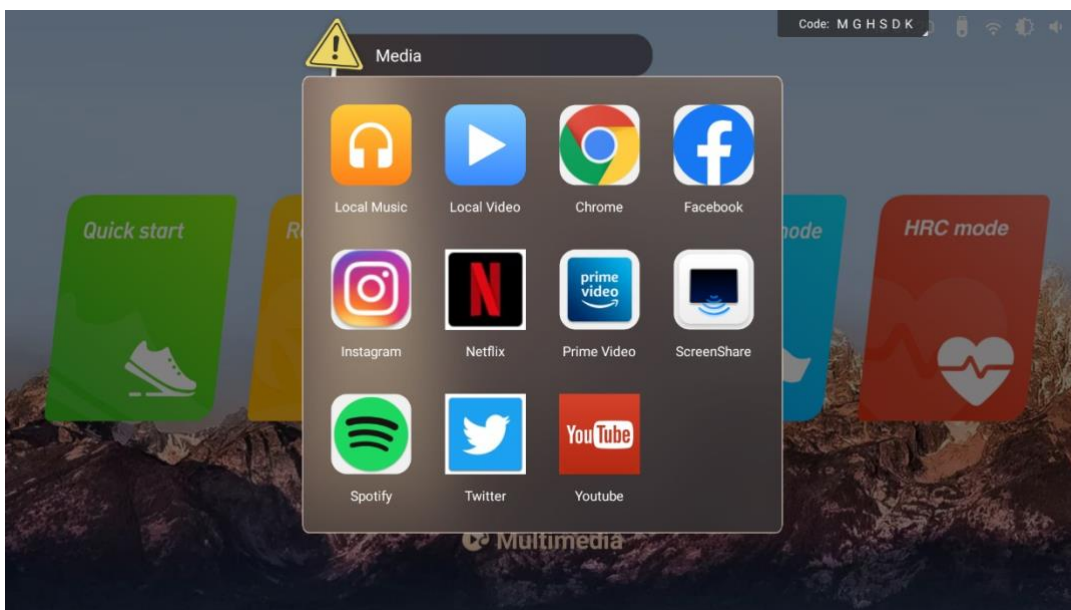

After starting the treadmill, press the speed adjustment button (+ -/ ) on the controlling panel or color screen to adjust your running speed. Press the incline adjustment key (+ -/ ) to adjust the comfortable running incline; Press the speed direct selection key (3-6-9) or fast selection key  on the screen to quickly select the speed; Press incline direct selection button (3-6-9) or quick selection button () on the screen to quickly select the incline. For your safety, try not to operate other functions on the screen when running. If you want to operate the media APP function, please do it when it is lower than 3KM/H or in the shutdown state. Click the "multimedia" icon on the interface to enter the APP interface, as shown in the picture below, you can browse Twitter, Facebook... and so on.



When the speed is > 1KM/H, click the "  ", the speed will be reduced to a comfortable state and the incline to the initial state value. When you want to stop running, press the "  " on the home page or the "  " button on the controlling panel, and a window that is about to end running will pop up on the home page to provide " Go on " or " Stop ", as shown below:

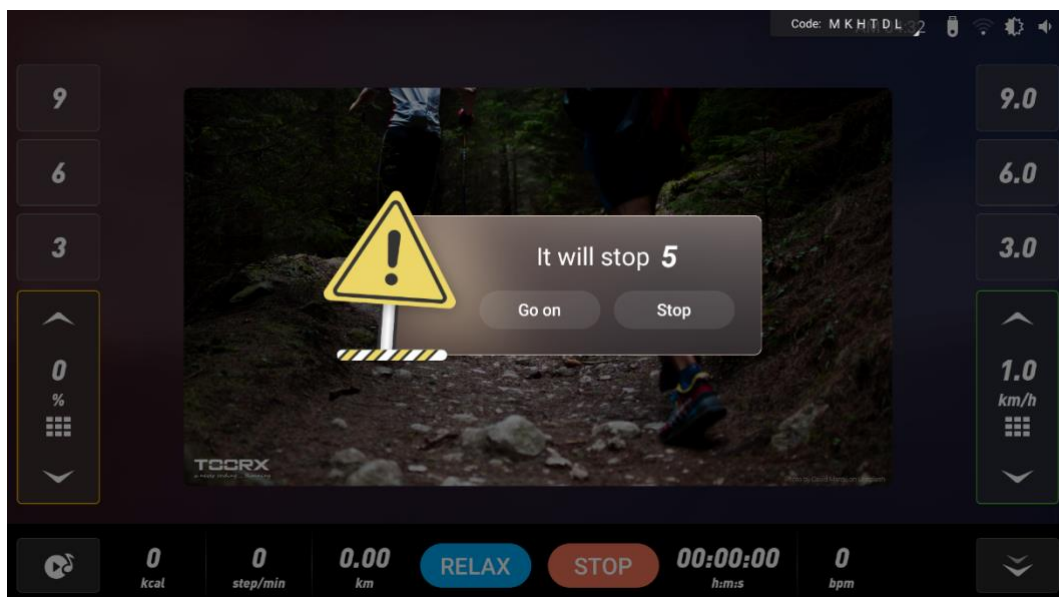

If you need to stop running in an emergency, please pull out the safety key or press the emergency stop button to stop the treadmill. Then it will be shown as below:

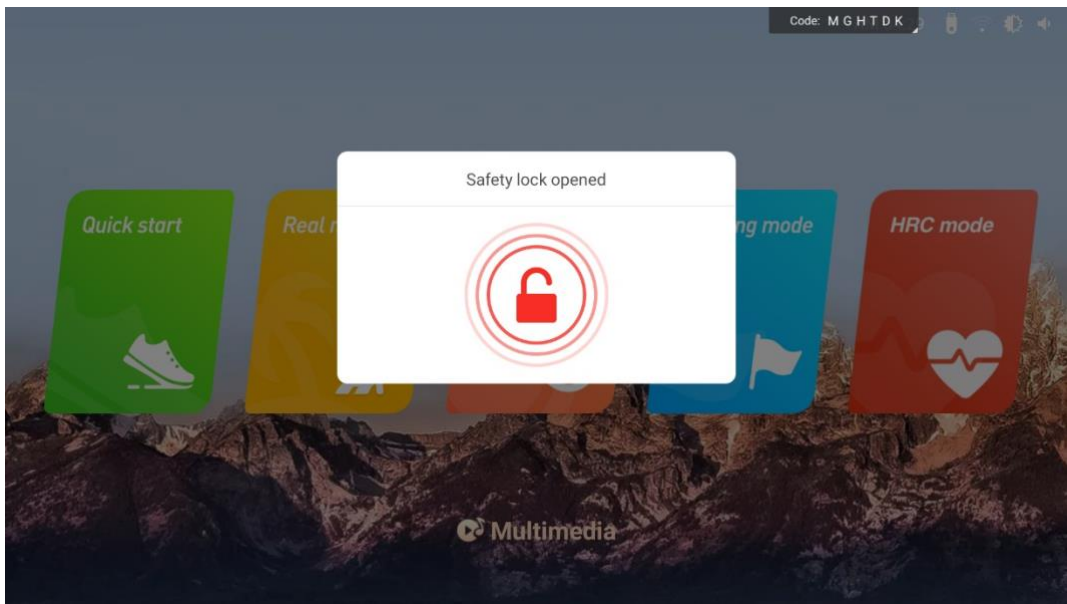

After inserting the safety key, it will switch to the main menu page, as shown below:

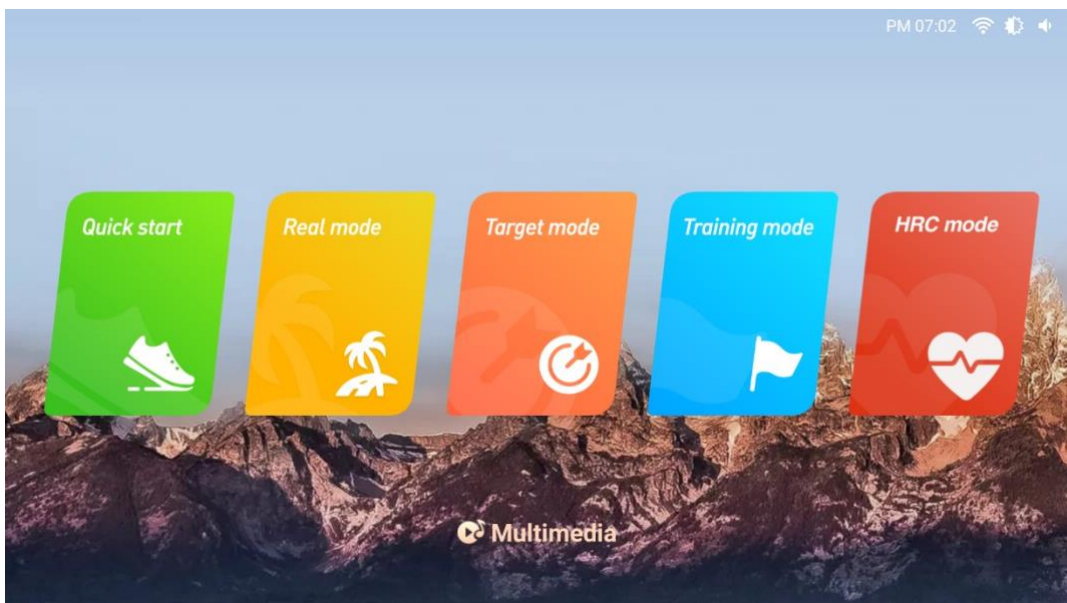

In the standby mode, you can choose the Quick start mode, Real mode, Target mode, Training mode and other sports programs to train, and you can also choose Multimedia for other operations.

## 2. Controlling panel instruction

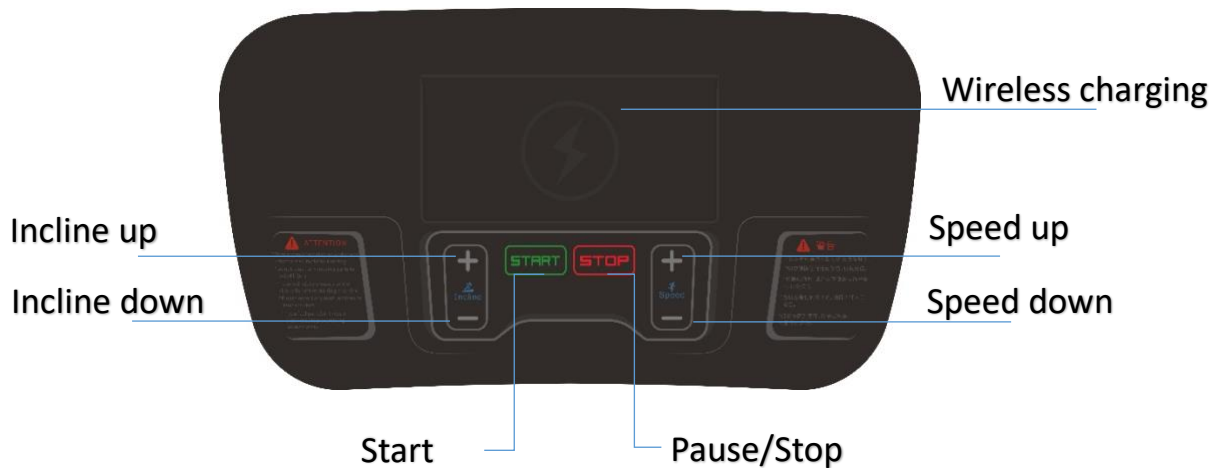

### 2.1 Mechanical button operation



**Start:** after power on, press “START”, the treadmill starts running.



**Stop/pause:** press this button when running, the treadmill will pause, and press again to stop running. After the pause, press the start button and the treadmill will return to the running state before the pause.



**Speed adjustment:** when the treadmill is running, press this key to adjust the speed, keep pressing will lead to fast adjustment.



**Incline adjustment:** when the treadmill is running, press this key to adjust the incline, keep pressing will lead to fast adjustment.





**Emergency stop button/Safety key:** it is a safety device to prevent slipping or forced shutdown in emergency. When using the treadmill, you need to insert the safety key inward (after inserting the safety key, the emergency stop button will automatically reset and spring up), press the emergency stop button or pull out the safety key side of the treadmill to stop running.





**Wireless charging:** when the treadmill is powered on, if the mobile phone has wireless charging function, put the mobile phone in the charging slot, and the wireless charging can play.

### 2.2 Buttons in touch screen

2.2.1  Quick start: when the treadmill is powered on, click this button then the treadmill starts to run.

2.2.2  Real mode: click this button to enter into the real scene selection interface.

2.2.3  Target mode: click this button to enter into the target selection interface.

2.2.4  Training mode: click this button to enter into the training selection interface.

2.2.5  HRC mode: click this button to enter into setting interface of HRC

2.2.6  Multimedia: click this button to view different applications.

2.2.7 :click this button to return to the previous menu.

2.2.8 :click this button to switch to the full screen.

2.2.9 : click this button to switch to the initial interface.

2.2.10  Stop: click this button to stop running the treadmill.

2.2.11  Relax: Click this button to reduce the treadmill speed/incline to the initial state of comfortable exercise.

2.2.12  Speed/Incline up: click this button to increase running speed / incline.

2.2.13  Speed/Incline down:click this button to decrease running speed/incline.

2.2.14  Quick speed selection: click this button to enter quick speed selection.

2.2.15  Quick incline selection:click this button to enter quick incline selection.

### 3. Display screen instruction



## 4. Instruction of running programs and setting operation

### 4.1 Treadmill operation instruction

Switch on the power, the treadmill enters into the standby state, press “START”, the treadmill starts to run, you can choose the speed or incline button to adjust, press “STOP” to stop running. In the standby state, if there is no signal input for a long time, the treadmill enters the black screen of shutdown standby state. Press any physical mechanical button to light up the screen and return to the standby. Before starting the treadmill, you can choose system settings or training mode.

### 4.2 Status bar and shortcut Settings

Under the power-on state, you can set the system. Through the status bar and shortcut setting area in the upper right corner of the home page, you can open the shortcut setting menu, adjust the treadmill volume, screen brightness and set bluetooth. Advanced Settings are the management menu of treadmill, it is non-user menu, but only for equipment maintenance personnel. As shown below:

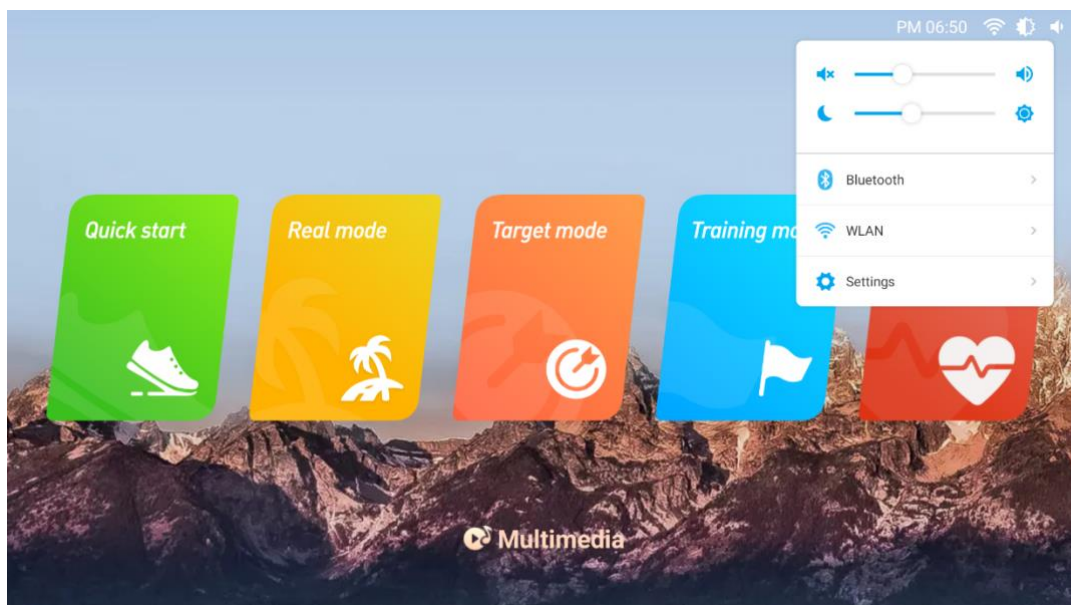

### 4.3 Real mode

Click "REAL MODE" on the screen, the treadmill enters the real scene selection interface with six built-in scenes, as shown below:

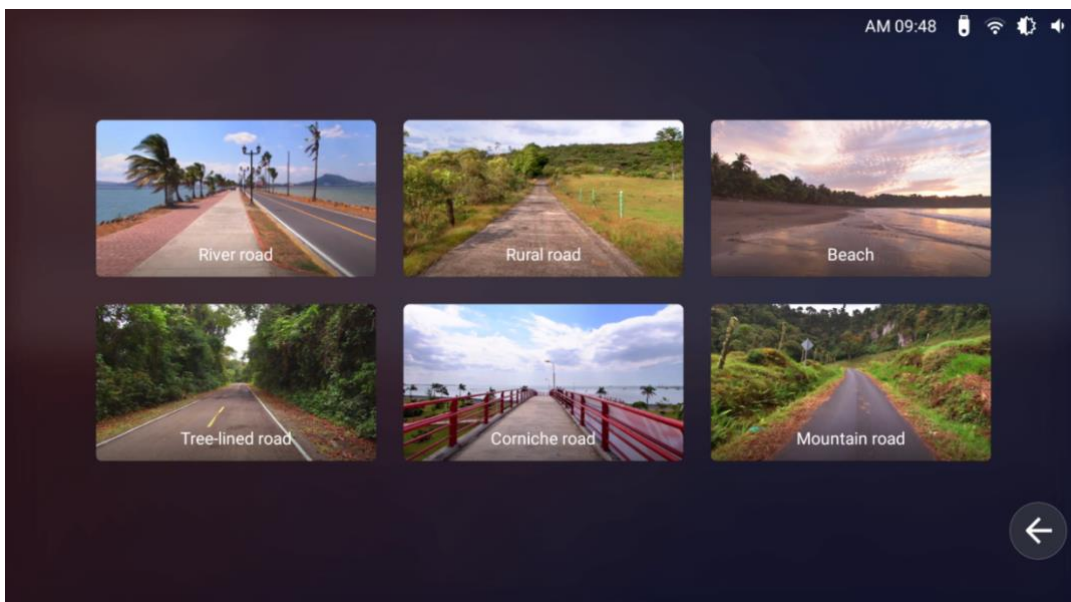

Users can choose their favorite real scene, click to enter the scene running. For example: the user chooses "Beach" real scene, beach scene running will be started. As shown below:

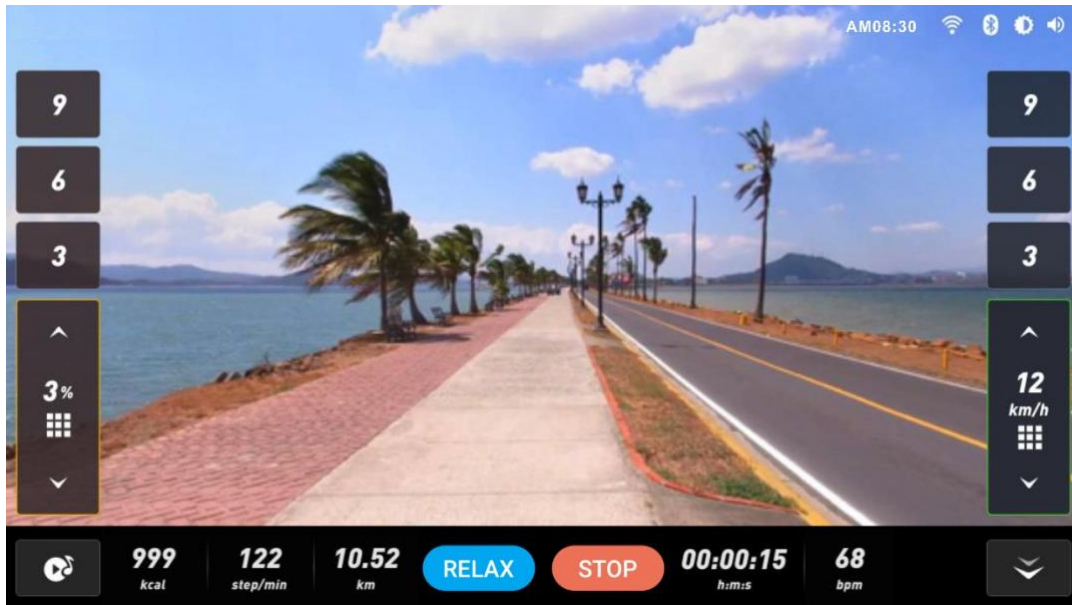

Press the speed adjustment button (+ -/ ) on the controlling panel or screen to adjust the speed of running. Press the speed direct selection key (3-6-9) or fast selection key ( ) on the screen to quickly select the speed. Note: In the real running mode, there is no need to adjust the incline. The system will automatically set it according to the terrain changes in the real scene.

#### 4.4 Target mode

Click "TARGET MODE" to enter the target selection interface, which has three types, as shown below:

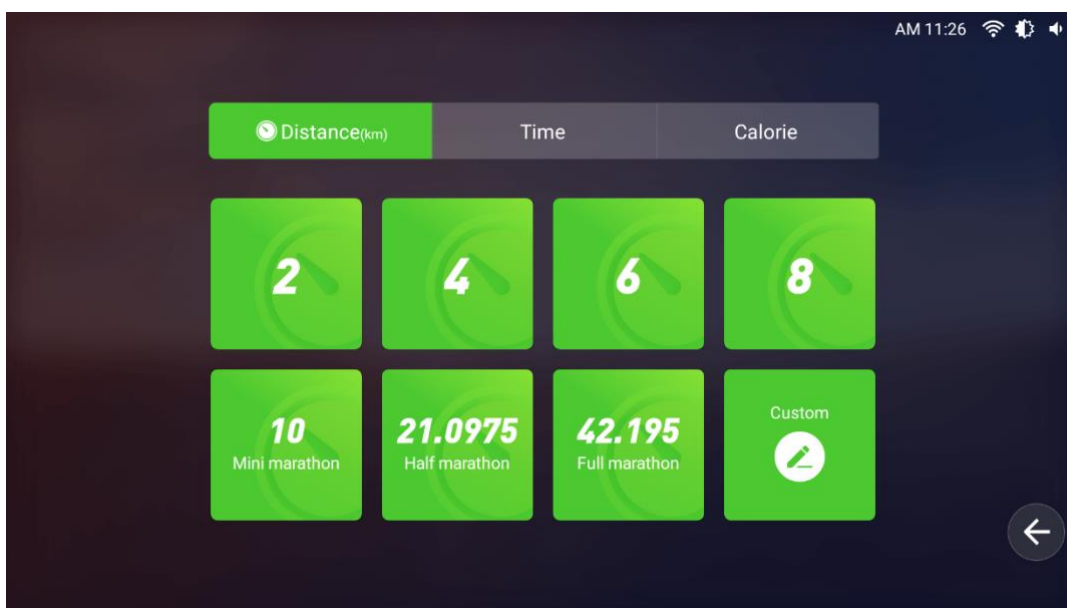

**4.4.1 Distance:** Built-in 2/4/6/8/ Mini marathon/half marathon/full marathon/custom options. The distance will gradually decrease as you run, then come to end when it drop to 0.

Users can select their target distance and click to enter the running interface. For example, users can select a "4km" to start . As shown below:

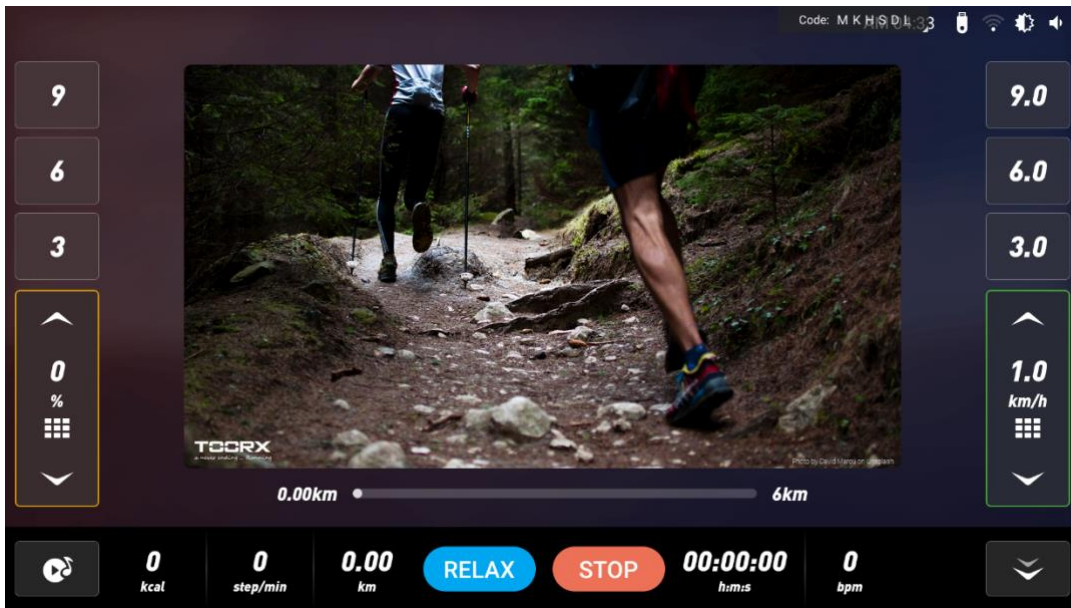

**Custom mode:** Press the button to enter into the setting interface. After setting, click "Start running" to run. As shown below:

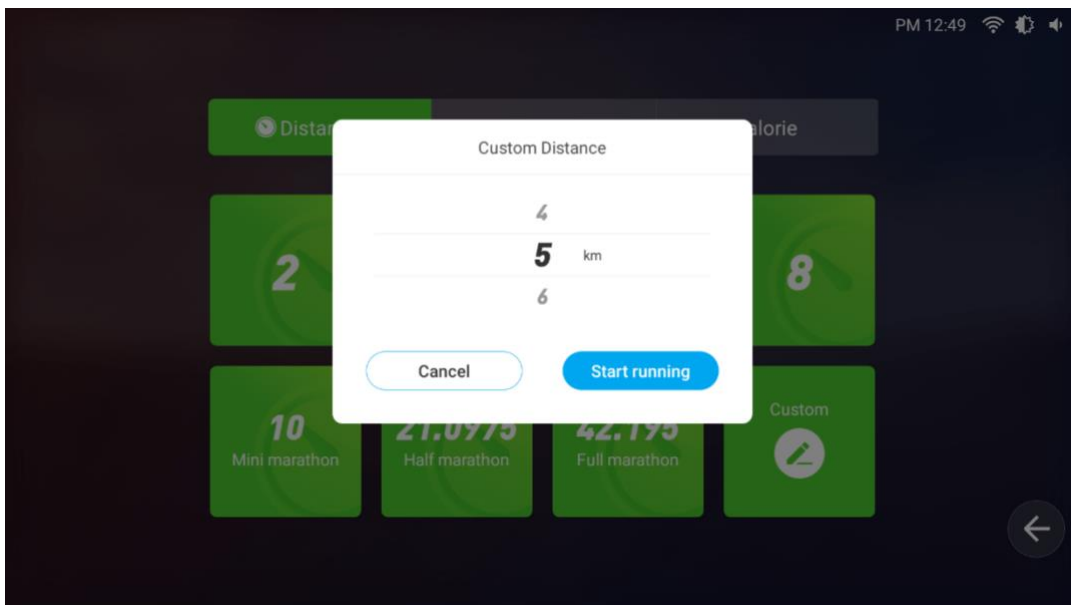

**4.4.2 Time:** Built-in 15/30/45/60/90/120/150/custom options. The setting time will gradually decrease as you run, then come to end when it reaches 0.

Users can select their target time and click to enter the running interface. For example, the user selects the "15 minute" to start. As shown below:



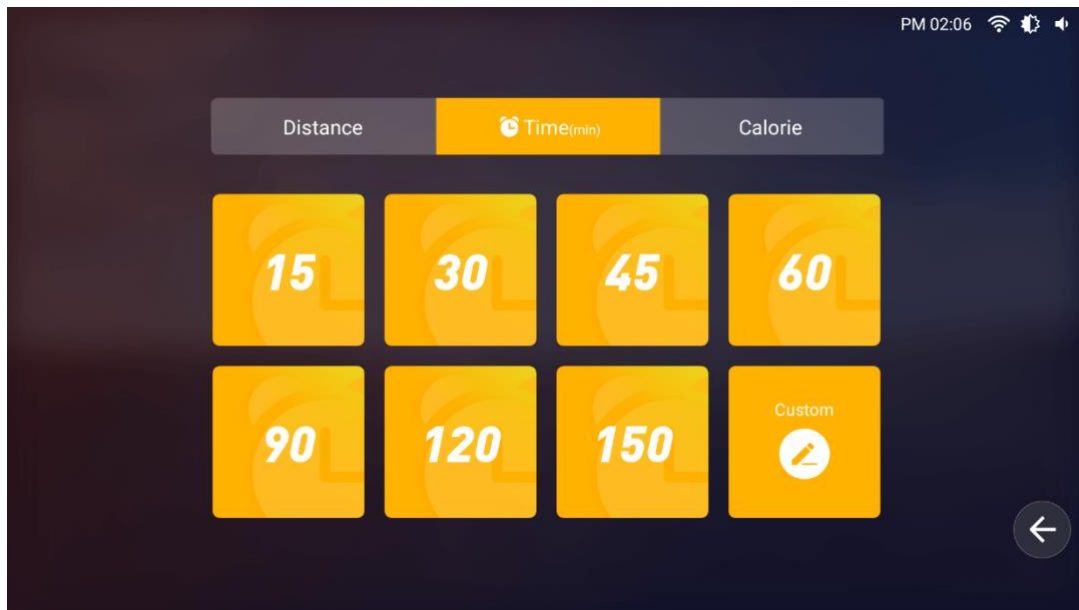

**Custom mode:** Press "Custom" to enter the setting interface. After setting, click "Start running" to run. As shown below:

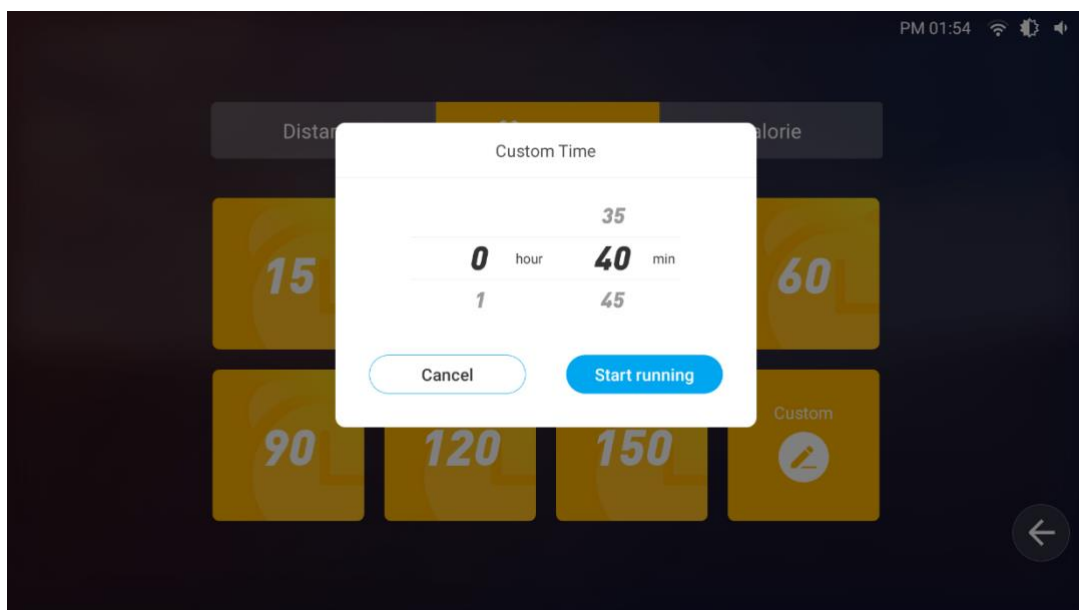

**4.4.3 Calorie:** Built-in for 100/200/300/400/500/1000/1500 / custom options. The setting calories will gradually decrease as you run, then come to end when it reaches 0.

Users can select their target calorie and click to enter the running interface. For example, the user selects the "100" to start. As shown below:

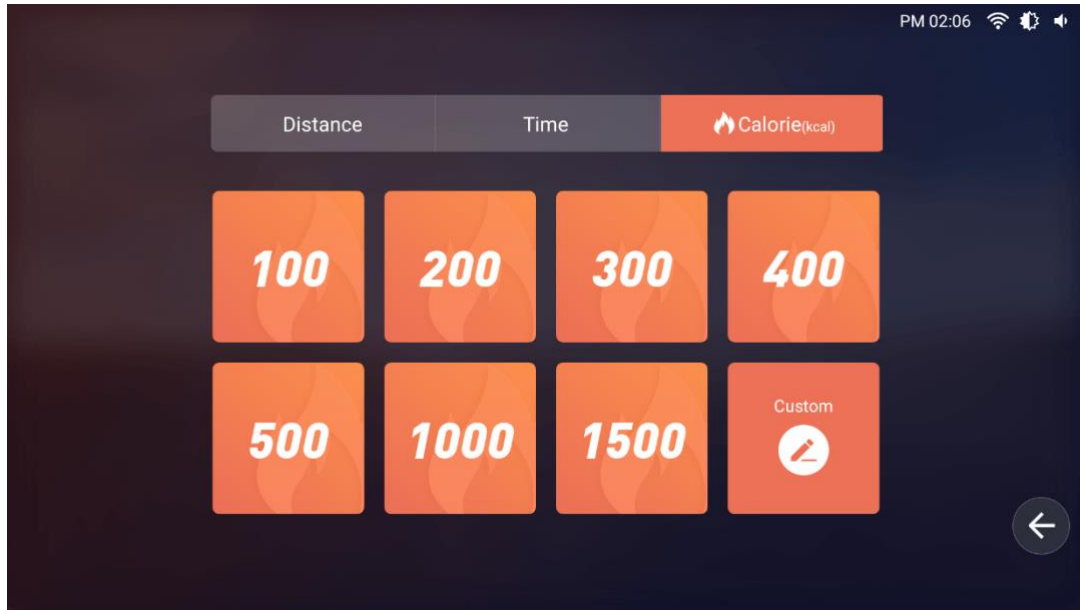

**Custom mode:** Press "Custom" to enter the setting interface. After setting, click "Start running" to run. As shown below:

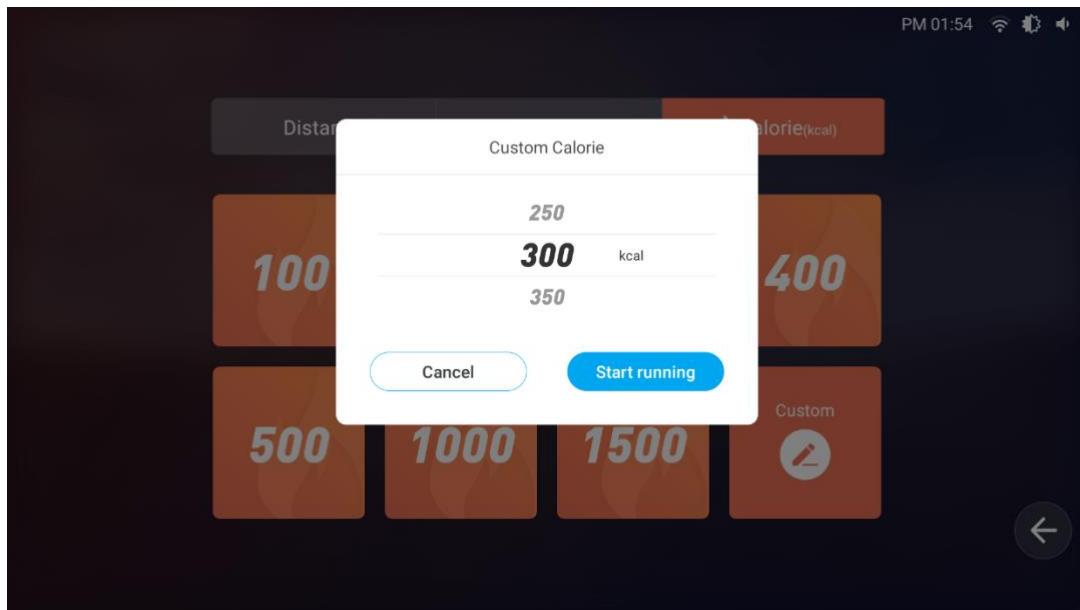

#### 4.5 Training mode

Click "Training mode" to enter the selection interface, as shown below:

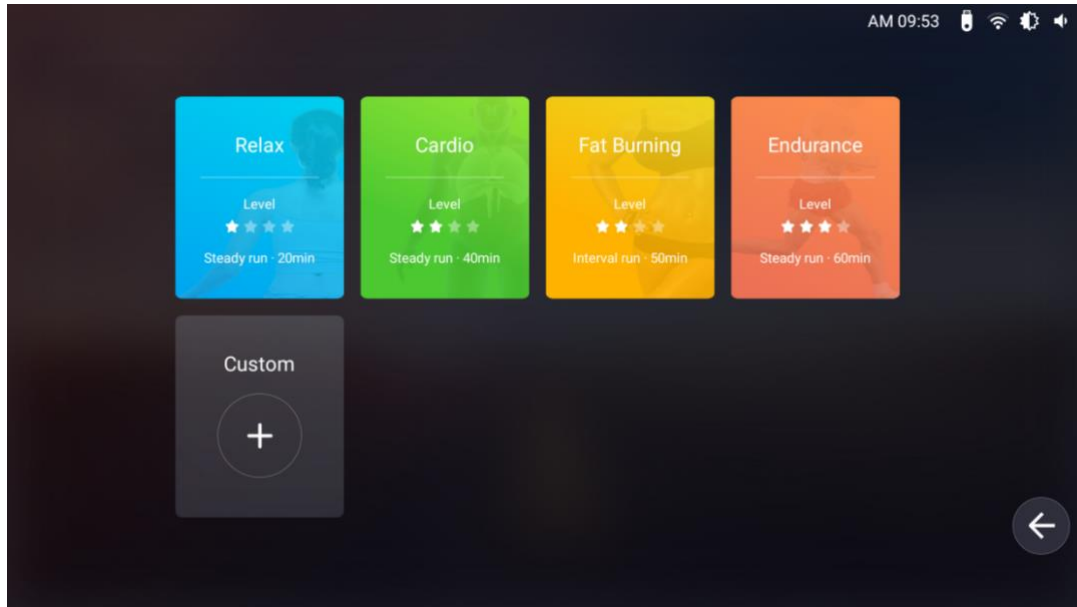

4.5.1 In the training mode, the system provides a variety of preset training plans of Relax, Cardio, Fat burning and Endurance for different running styles to help train stretching. Different running modes have different incline and paces, so users can concentrate on running without worrying about various Settings.

4.5.1.1 Users can select the training mode and click to enter the running interface. For example, when users select "Relex", they can start running in this mode. As shown below:

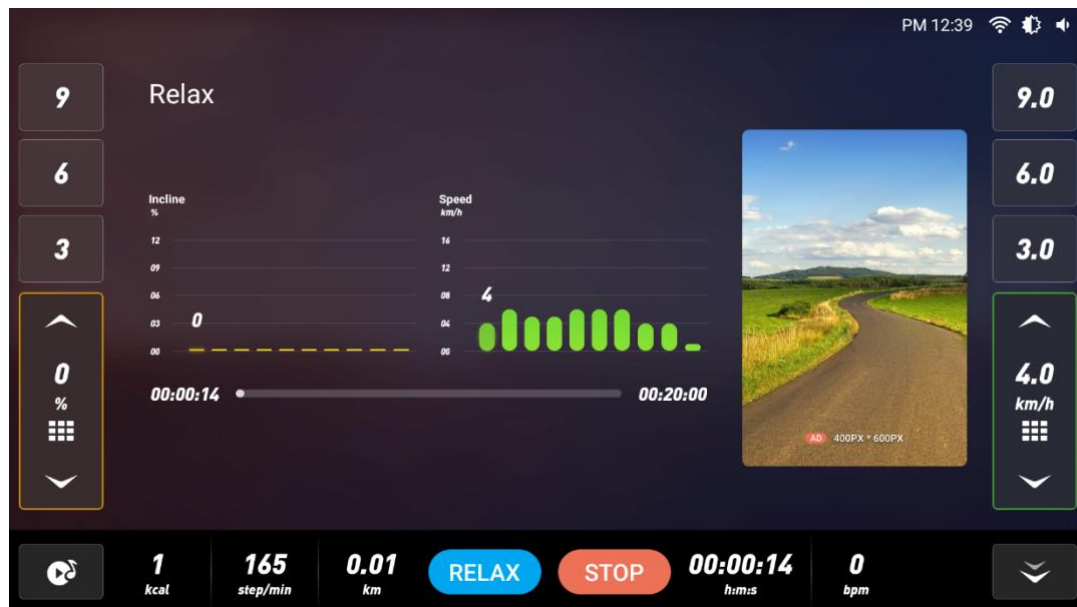

4.5.2 Cardio mode, as shown below

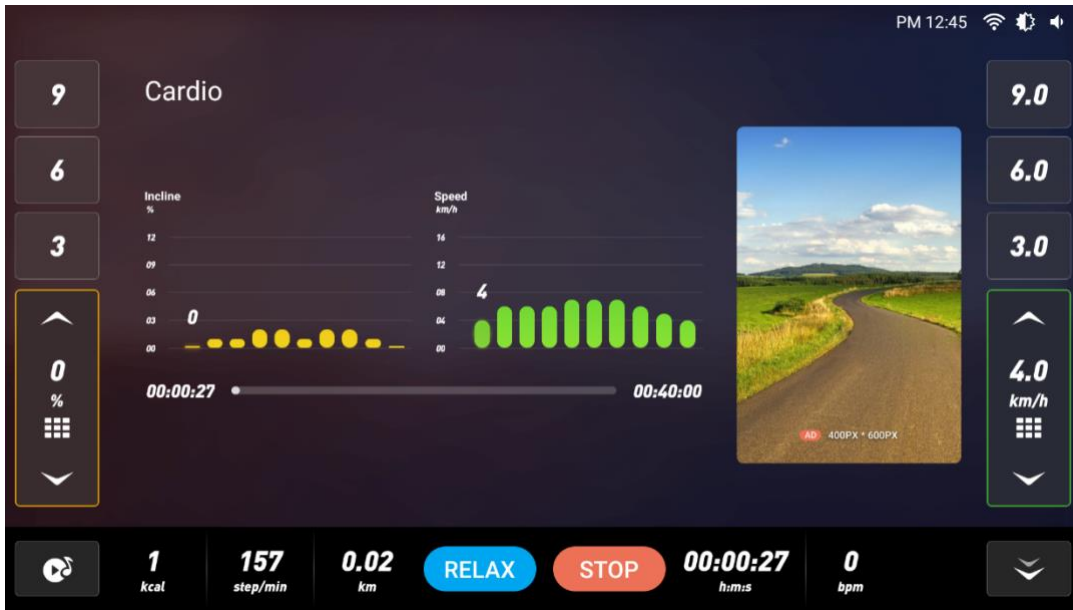

4.5.3 Fat burning mode, as shown below:

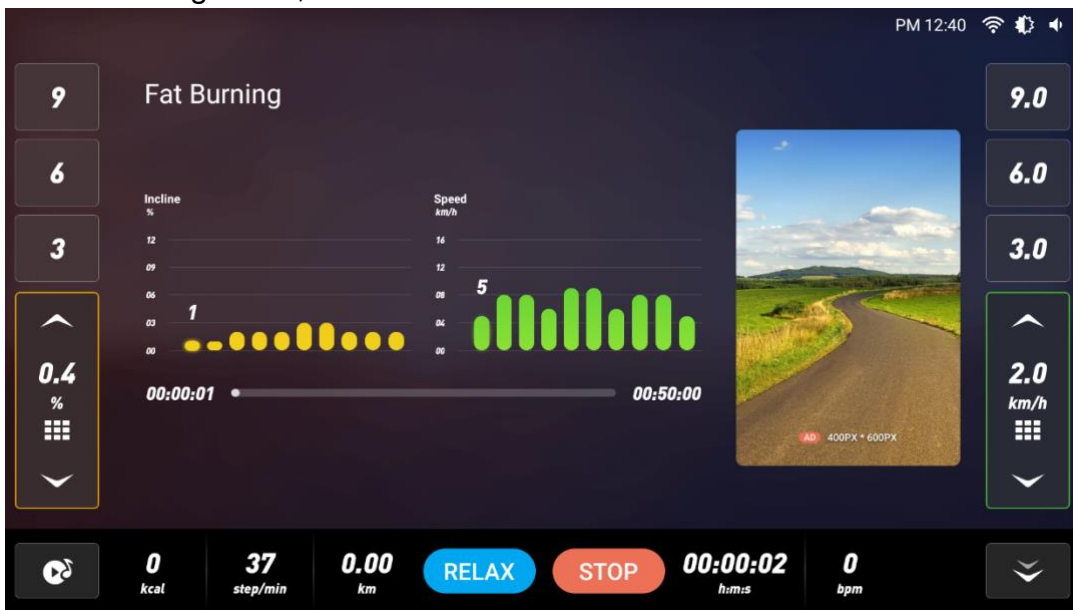

4.5.4 Endurance mode, as shown below

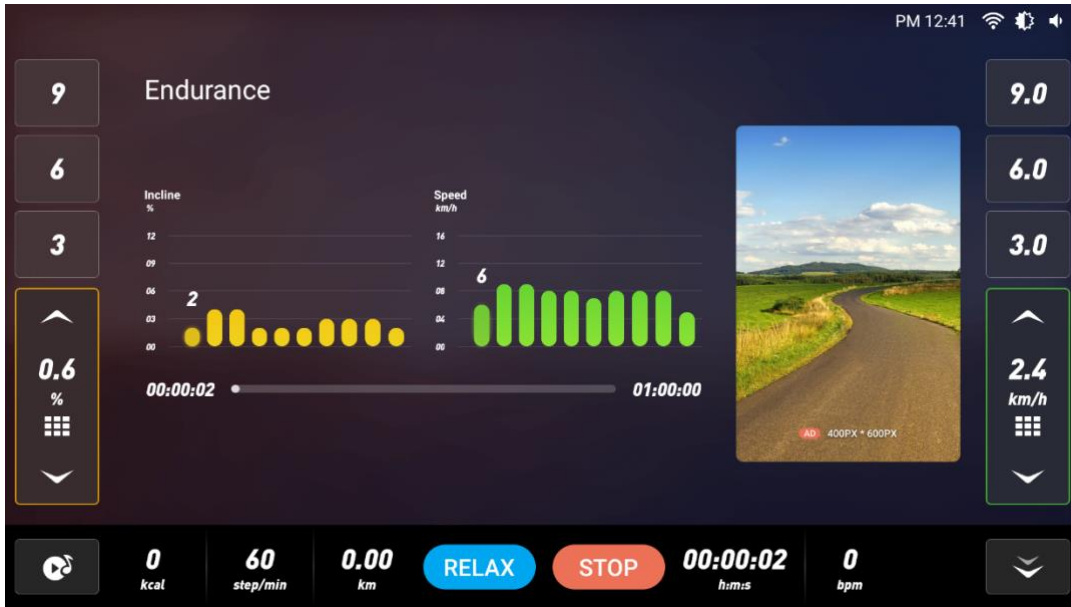

4.5.5 Custom mode: If the preset training mode cannot meet users' requirements, they can customize the training mode, including: running time, incline and speed of each running stage. You can press and drag any rectangular bar to set different incline changes and different pace parameters in different time periods. After setting, click "START" to run, as shown below:

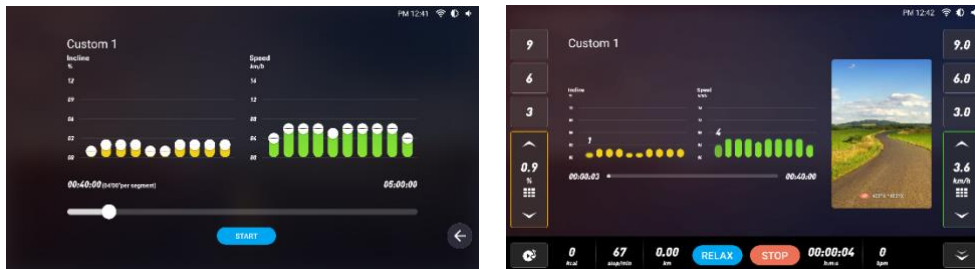

4.6 Heart rate control mode: click "HRC Mode" to enter into heart rate control setting page, such as "Age"- "Gender"- "Percentage of difficulty"- "Time" - "Max heart rate"- "Min. Heart rate" are default value , then click "START" to start running under heart rate control mode, as shown below:

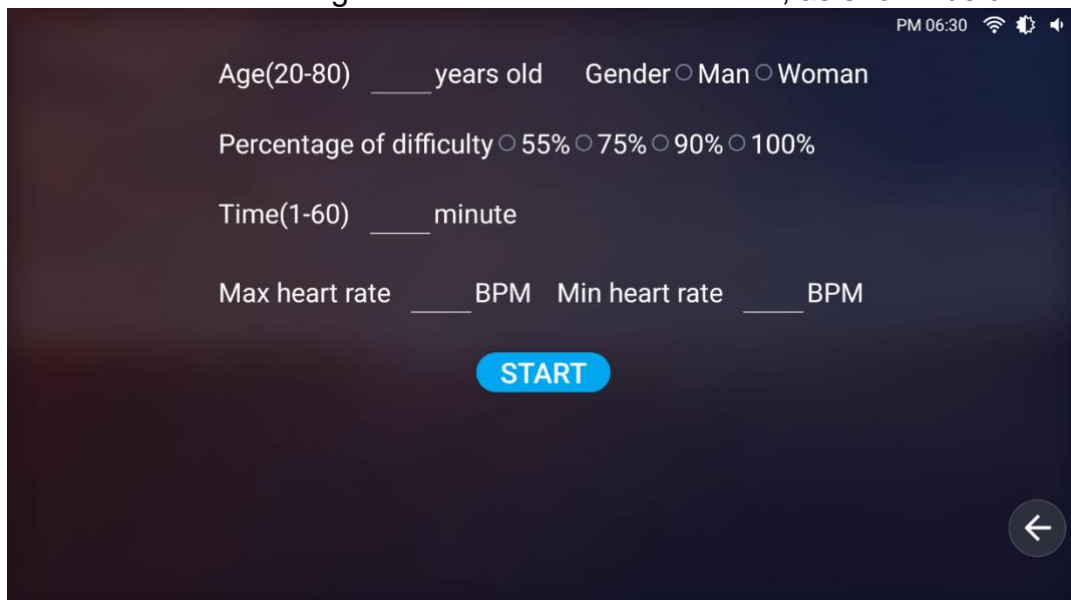

When running in heart rate control mode, please put your left and right hand on the heart rate detector or wear a wireless heart rate band, as shown below:

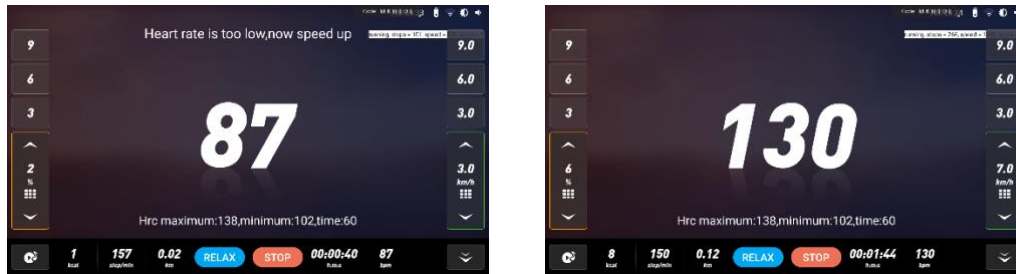

5. Exercise summary: when the distance is  $\geq 0.1$ km, the system will automatically record the relevant exercise data (the data will be automatically cleared after exiting the interface), as shown below:

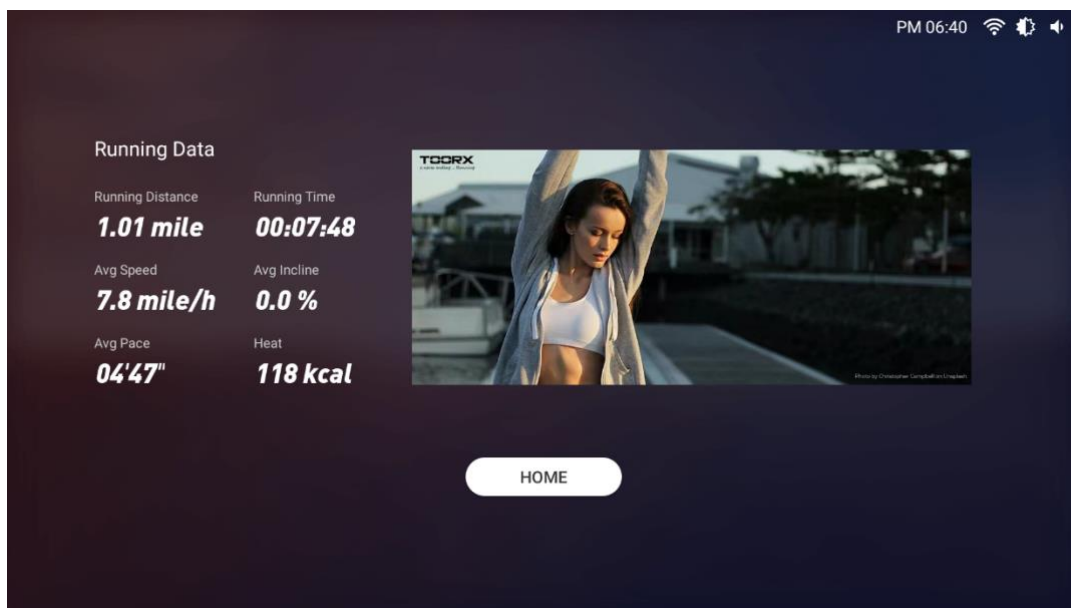

## 5.Multimedia

Click "Multimedia" to enter application selection interface , as shown below:

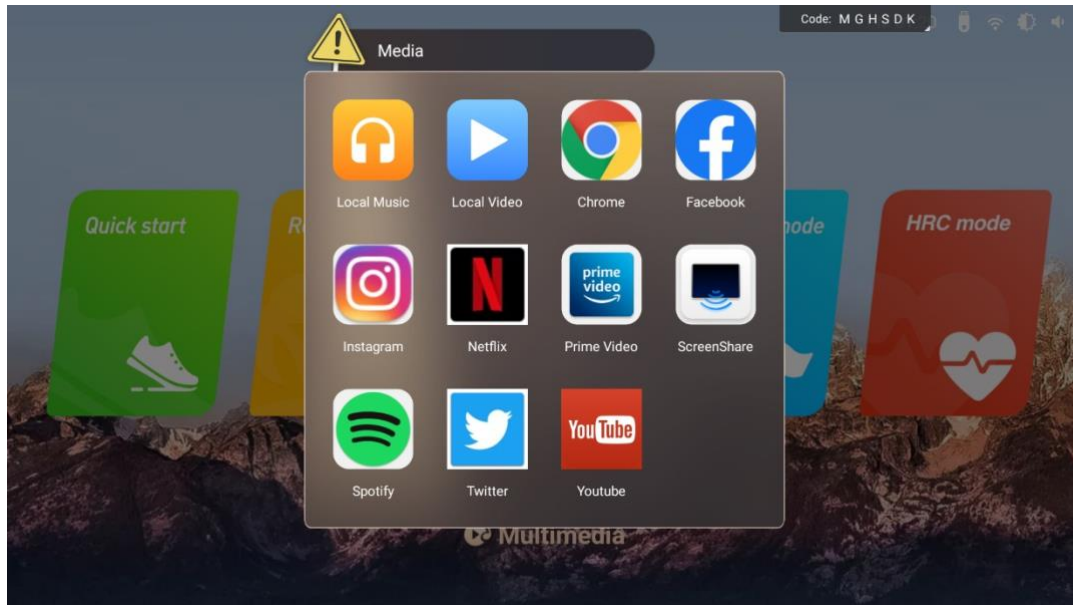

\*Remark: Because the software is constantly updated and iterated, if the actual interface is inconsistent with that in this instruction, the actual interface prevails, this document is for reference only.

### ◆ Heat rate test

The test can detect static and dynamic heart rate before and after exercise, and recovery after exercise. The user holds the metal plate of heart rate detection on the left and right horizon handlebar with both hands, then the heart rate value will be displayed on the screen. (Warm reminder: the maximum heart rate of the exerciser should not exceed  $(220 - \text{age})$ . When the heart rate exceeds the maximum, it is recommended to rest for about 30 minutes or slow down and reduce the incline. The detected heart rate is only for the reference of sports and fitness.

Tips: When using wireless heart rate, please do not use in MP3 mode, to prevent the interference of two signals, and a special wireless heart rate chest band is required.

Warning: Heart rate monitoring system may be inaccurate. Excessive exercise can result in serious injury or death. Stop exercising immediately if you feel faint.

### ◆ Interface instruction

#### 1. Audioport

When walking, you can wear headphones and plug the earphone into the audio port to listen to the voice on the headphones.

#### 2. USB input

Insert the USB flash drive into the port on the right of the display, and click the multimedia to play songs

and videos on the USB in Local Music and Video.

### 3. Bluetooth

The bluetooth of this treadmill is set as the main device, which can recognize and connect bluetooth speakers, earphones and other bluetooth peripheral.

### 4. ScreenShare

4.1 Enter multimedia - click ScreenShare - scan QR code to download the assistant application in your mobile phone;

4.2 Open the share application in your mobile phone;

4.3 Follow the instructions to operate in your mobile phone, then the touch screen can be shared in your mobile phone.

### 5. FIT APP instruction (if have)

5.1 Scan the QR code to download the "FIT" application in your mobile phone or tablet PC.

5.2 Turn on bluetooth in your mobile phone or tablet PC;

5.3 Turn on the treadmill;

5.4 Connet the treadmill.



**Warning:** To ensure the safety and normal use, check the wear and damage of the treadmill regularly.

### Maintennance and malfunction treatment

1. Clean: The surface of the treadmill should be kept clean, pull out the power cord before cleaning. You can clean the running belt and the surface of the treadmill with a soft and wet cloth, be sure not to use strong solvents.

2. Adjustment of belt deviation: The running belt has been adjusted when manufactured; it may runs defectively after transportation and use. Turn off the treadmill before adjusting, (see figure) adjust the left and right bolts in rear roller with wrench If the belt deviates to the left, clockwise rotate the left bolt. If the belt deviates to the right, counterclockwise rotate the right bolt. It is better to adjust 1/2 circle at a time. After adjustment, turn on the power and start the treadmill to check if the belt back to center at speed of 4-5km/h, repeat the

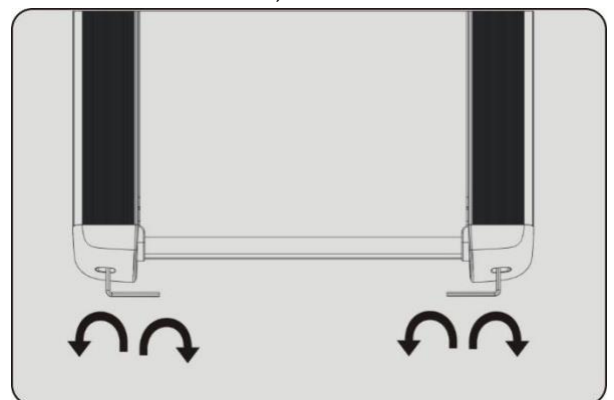



procedure if not.

3. Adjustment of belt slip: After a certain time of using, the belt might turn to be longer or couldn't free roll..

Your should adjust the left and right bolts in rear roller clockwise at same position till it runs smoothly and freely, it is better to adjust 1/2 circle at a time .But to avoid shortening belt using lifetime, do not adjust it too tight.

4. Lubricate

After using over 100 hours or the lubricant between the running board and the running belt is used up, please lubricate the running board and adjust the running belt well.

4.1 Power off, loose the belt by using the method of belt deviation adjustment, then brush lubricant to the running board evenly.

4.2 Please do not lubricate excessively, lubricant is not the more the better, reasonable lubrication can improve the service life of the treadmill.

## Maintenance reminding function

The treadmil has been lubricated before leaving the factory, it is not necessary to add lubricant oil when the treadmill runs first time. In order keep the transmission parts of the treadmill in the best condition, the treadmill is equipped with reminding function of belt lubricating and replacing.

When the treadmill runs to 800km, "Need lubrication" will be displayed on left upper corner of the screen, it means need to add oil to the treadmill; After the first time oiling, the next reminding will be displayed every 800km.

After lubrication, press and hold the INCLINE+ and SPEED+ at the same time, lubrication Reminding will be removed.

When the treadmill runs to 15000km, "Need to change belt" will be display on left upper corner of the screen, it means need to replace the belt.

Click "Status bar& Shortcut setting area" to enter into "Advanced setting", then clip "Treadmill Manager", and clip "Close" to exit the reminding.

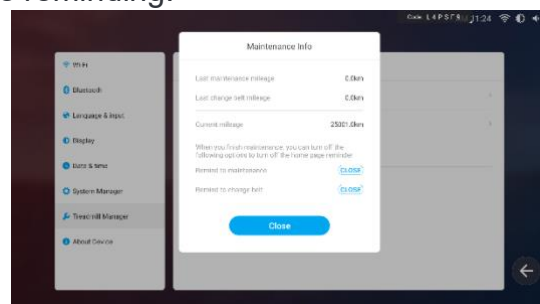
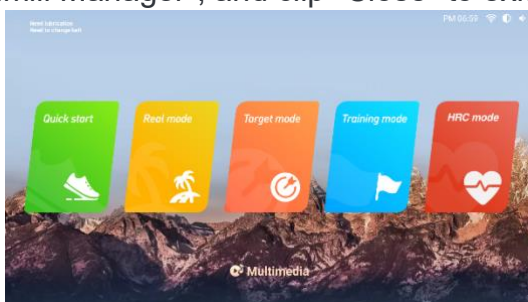

## Exercise guidance

Consult your doctor before starting exercise program. This is especially important for people over 35 or with health problems. Heart rate sensors are not medical facilities. Many factors can affect its accuracy . In general, the sensors can only be used as an exercise aid to determine general heart rate trends.

The following guidelines can help you plan your exercise program. For more detailed exercise information, please consult your doctor.

### Exercise intensity

Whether your goal is to burn fat or strengthen your cardiovascular system, the key to achieving the desired results is the right intensity of exercise. Use your heart rate as a guide to find the right level. The table below lists the recommended

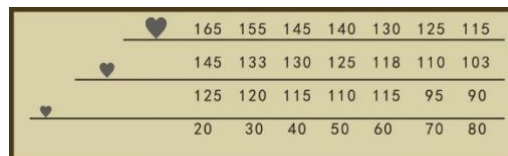

165	155	145	140	130	125	115
145	133	130	125	118	110	103
125	120	115	110	115	95	90
20	30	40	50	60	70	80

heart rates for fat burning and aerobic exercise. To find your heart rate, start by finding your age (rounded to a full ten) at the bottom of the chart. Then find the three numbers above your age. These three numbers identify your "training program selection area." The following two numbers are recommended for burning fat. The numbers above are recommended for aerobic exercise. To measure your heart rate during exercise, use a pulse sensor on your console.

### Fat burning

To burn fat effectively, you must exercise at a relatively low intensity for long periods. In the first five minutes of exercise, your body burns carbohydrate calories for energy because they are easier to use. It is only after the first five minutes that the body begins to burn off stored fat. If your goal is to burn fat, adjust the pace and incline of the treadmill until the heart rate is close to the lower limit of the training area. To maximize fat burning, adjust the pace and incline of the treadmill until the heart rate is close to the middle of the training zone.

### Cardio exercise

If your goal is to strengthen your cardiovascular system, you must do cardio exercise, which is prolonged activity that requires a lot of oxygen. The heart must pump more blood to the muscles, and the lungs must supply more oxygen to the blood. For cardio exercise, adjust the speed and incline of

the treadmill until the heart rate is close to the upper limit of the training area.

### **Exercise process**

Each exercise should include the following three parts:

**Warm up**--Before each session, do 5-10 minutes of stretching and light exercises. A proper warm-up can increase body temperature, heart rate and circulation, let your body prepare for exercise.

**Selection Zone Exercises** - After warming up, increase the intensity of the exercise until your heart rate reaches your selection zone and hold it for 20-60 minutes. (During the first few weeks of your exercise program, don't keep your heart rate in the exercise area for more than 20 minutes.) When exercising, take regular deep breaths and don't hold your breath.

**Cool down**--After completing exercise, cool down by stretching for 5-10 minutes. This increases muscle flexibility, which helps prevent post-exercise problems.

### **Exercise frequency**

To maintain or improve your fitness, you need to complete exercises three times a week with at least one day interval. After a few months, you should be up to five times a week, depending on your needs.

The key to success is to make exercise a regular, enjoyable part of your daily routine.

A successful training program consists of prepping and finishing movements. The complete program is performed at least two to three times a week, with a break of one to two days between exercises, you can increase to four to five times a week after a few months. The warm-up before each workout is very important. It warms up your body gradually, stretches your muscles, increases blood circulation and heart rate, and delivers more oxygen to your muscles. Repeat these movements after your workout to slow your heart rate and reduce muscle soreness. We suggest the following actions:

## **Warming up and cooling down**

A successful exercise program consists of a warm-up, aerobic exercise, and a cool-down. Do the entire program at least two and preferably three times a week, resting for a day between workouts. After several months, you can increase your workouts to four or five times per week.

Warming up is an important part of your workout, and should begin every session. It prepares your body for more strenuous exercise by heating up and stretching out your muscles, increasing your circulation and pulse rate, and delivering more oxygen to your muscles. At the end of your workout, repeat these exercises to reduce sore muscle problems. We suggest the following warm-up and cool-down exercises:

### **1. Inner Thigh Stretch**

Sit with the soles of your feet together with your knees pointing outward. Pull your feet as close into your groin as possible. Gently push your knees towards the floor. Hold for 15 counts.



### **2. Hamstring Stretch**

Sit with your right leg extended. Rest the sole of your left foot against your right inner thigh. Stretch toward your toe as far as possible. Hold for 15 counts. Relax and then repeat with left leg extended.

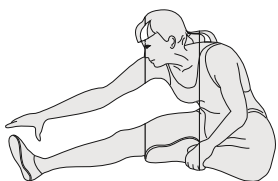

### 3. Head Roll

Rotate your head to the right for one count, feeling the stretch up the left side of your neck. Next, rotate your head back for one count, stretching your chin to the ceiling and letting your mouth open. Rotate your head to the left for one count, and finally, drop your head to your chest for one count.



### 4. Shoulder Lift

Lift your right shoulder up toward your ear for one count. Then lift your left shoulder up for one count as you lower your right shoulder.

### 5. Toe Touch

Slowly bend forward from your waist, letting your back and shoulders relax as you stretch toward your toes.

Reach down as far as you can and hold for 15 counts.

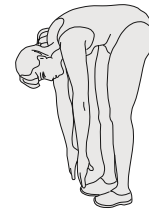
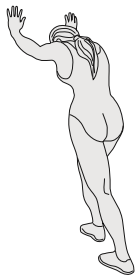

### 6. Calf-Achilles Stretch

Lean against a wall with your left leg in front of the right and your arms forward. Keep your right leg straight and the left foot on the floor; then bend the left leg and lean

forward by moving your hips toward the wall. Hold, then repeat on the other side for 15 counts.

### 7. Side Stretch

Open your arms to the side and continue lifting them until they are over your head. Reach your right arm as far upward toward the ceiling as you can for one count. Feel the stretch up your right side. Repeat this action with your left arm.





GARLANDO SPA  
Via Regione Piemonte, 32 - Zona Industriale D1  
15068 - Pozzolo Formigaro (AL) - Italy  
[www.toorx.it](http://www.toorx.it) - [info@toorx.it](mailto:info@toorx.it)